

Outil compact 8 ventouses Ø20

Ref article : A02136

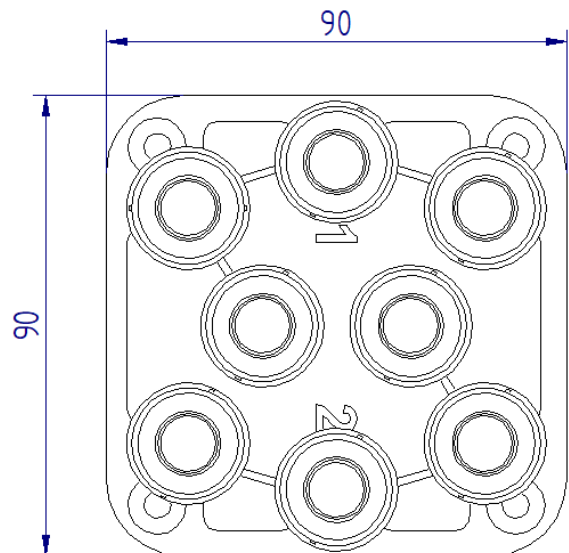

Dimensions :

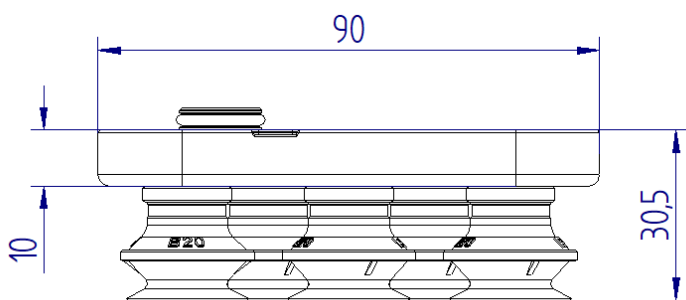

Matériaux	Base PA12
Masse	57 gr base seule
Taraudage	G1/8
Montage	4 vis Torx TF M5*16
Joint	inclus
Charge utile max	8 Kg