

Outil compact 4 ventouses Ø40

Ref article : A02146

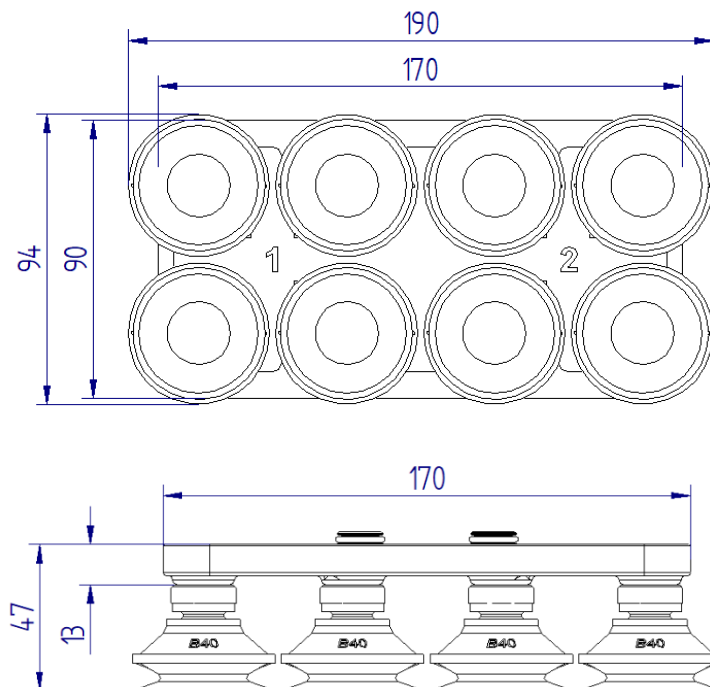

Dimensions :



Matériaux	Base PA12
Masse	104 gr base seule
Taraudage	G1/4
Montage	4 vis Torx TF M5*16
Joint	inclus
Charge utile max	32 Kg