

## Réduction G1/8 → M5

Ref article : A02198

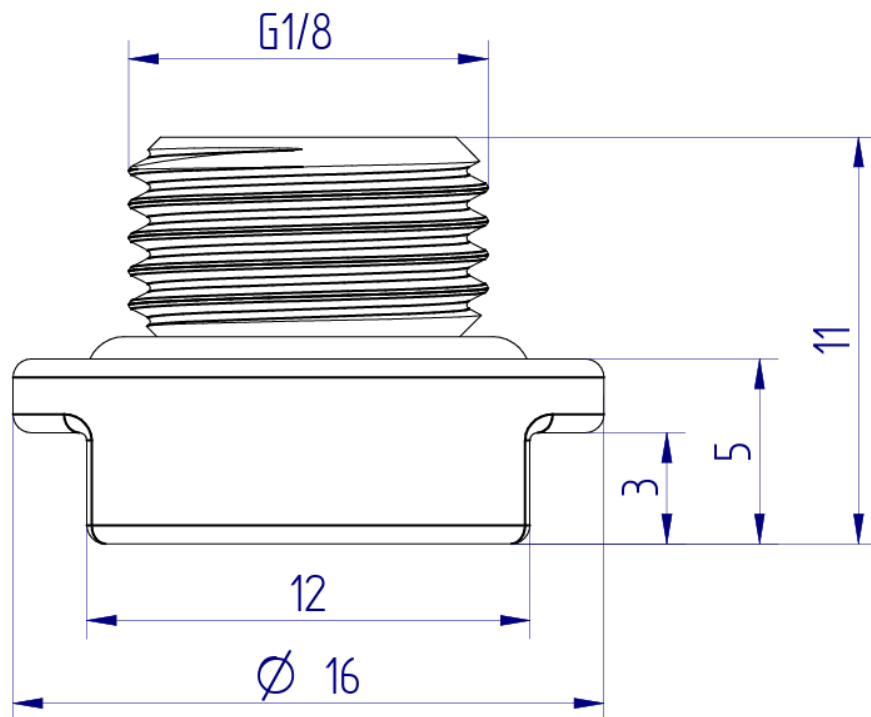

Dimensions :



Matériaux	PA12
Masse	1.5 gr
Filetage _ Taraudage	G1/8 male _ M5 femelle
Montage	Clé plate_ 12 mm
Joint	inclus